

# SERO. WORKSPACE.

Flexible. Affordable. Choice.



Manufactured in the UK



## SPECIFICATION GUIDE 2023.

ISSUE 1

# CONTENTS.

<b>BENCH DESKING.</b>	<b>04</b>
<b>STORAGE.</b>	<b>14</b>
<b>TABLES.</b>	<b>22</b>
<b>SEATING.</b>	<b>29</b>
<b>FINISHES.</b>	<b>32</b>
<b>OUR OTHER SERVICES.</b>	<b>34</b>



# BENCH DESKING.

Sero Bench Desking is a flexible and complete range of furniture. We can offer you affordable pricing as well as an infinite range of sizes and finish options that will ensure this is a successful product for many years to come.

- Frames can be powder coated in special finishes.
- Sizes can be tailored to your needs.
- We can offer cable management solutions for specific requirements.
- We have a full range of complementary screens available for this range.

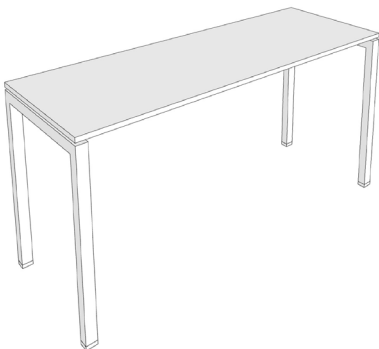

## BENCH DESK 600D

CODE	H	W	D
BD086	740	800	600
BD106	740	1000	600
BD126	740	1200	600
BD146	740	1400	600
BD166	740	1600	600
BD186	740	1800	600
BD206	740	2000	600

Cable trays not included

# BENCH DESKING.

## BENCH DESK 800D

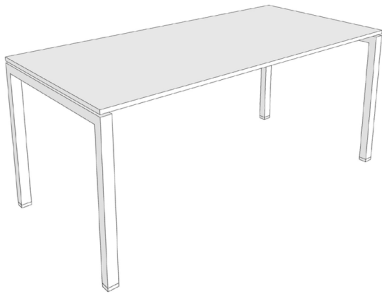

CODE	H	W	D
BD088	740	800	800
BD108	740	1000	800
BD128	740	1200	800
BD148	740	1400	800
BD168	740	1600	800
BD188	740	1800	800
BD208	740	2000	800

Cable trays not included

## MODESTY PANELS



CODE	H	W
MOD08	300	650
MOD10	300	850
MOD12	300	1050
MOD14	300	1250
MOD16	300	1450
MOD18	300	1650
MOD20	300	1850

Heavy duty brackets included

## BACK TO BACK BENCH 1200D



CODE	H	W	D
2PBB0812	740	800	1200
2PBB1012	740	1000	1200
2PBB1212	740	1200	1200
2PBB1412	740	1400	1200
2PBB1612	740	1600	1200
2PBB1812	740	1800	1200
2PBB2012	740	2000	1200

Cable trays not included



# BENCH DESKING.



## BACK TO BACK BENCH 1600D

CODE	H	W	D
2PBB0816	740	800	1600
2PBB1016	740	1000	1600
2PBB1216	740	1200	1600
2PBB1416	740	1400	1600
2PBB1616	740	1600	1600
2PBB1816	740	1800	1600
2PBB2016	740	2000	1600

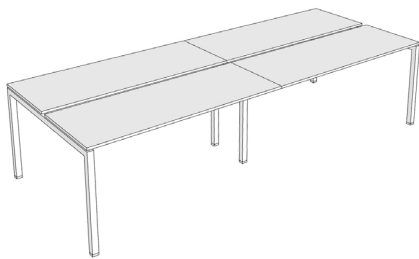

## 4 PERSON BACK TO BACK BENCH 1200D

CODE	H	W	D
4PBB1612	740	1600	1200
4PBB2012	740	2000	1200
4PBB2412	740	2400	1200
4PBB2812	740	2800	1200
4PBB3212	740	3200	1200
4PBB3612	740	3600	1200
4PBB4012	740	4000	1200

Cable trays not included

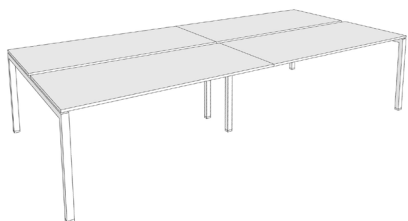

## 4 PERSON BACK TO BACK BENCH 1600D

CODE	H	W	D
4PBB1616	740	1600	1600
4PBB2016	740	2000	1600
4PBB2416	740	2400	1600
4PBB2816	740	2800	1600
4PBB3216	740	3200	1600
4PBB3616	740	3600	1600
4PBB4016	740	4000	1600

Cable trays not included

# BENCH DESKING.

## 6 PERSON BACK TO BACK BENCH 1200D

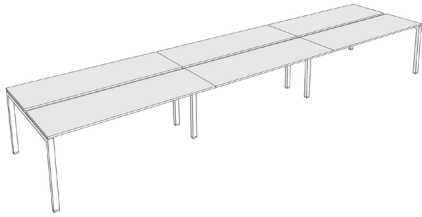

CODE	H	W	D
6PBB2412	740	2400	1200
6PBB3012	740	3000	1200
6PBB3612	740	3600	1200
6PBB4212	740	4200	1200
6PBB4812	740	4800	1200
6PBB5412	740	5400	1200
6PBB6012	740	6000	1200

Cable trays not included

## 6 PERSON BACK TO BACK BENCH 1600D

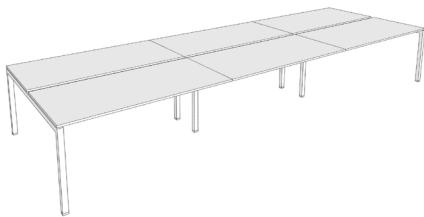

CODE	H	W	D
6PBB2416	740	2400	1600
6PBB3016	740	3000	1600
6PBB3616	740	3600	1600
6PBB4216	740	4200	1600
6PBB4816	740	4800	1600
6PBB5416	740	5400	1600
6PBB6016	740	6000	1600

Cable trays not included

## 8 PERSON BACK TO BACK BENCH 1200D

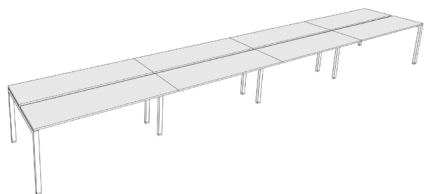

CODE	H	W	D
8PBB3212	740	3200	1200
8PBB4012	740	4000	1200
8PBB4812	740	4800	1200
8PBB5612	740	5600	1200
8PBB6412	740	6400	1200
8PBB7212	740	7200	1200
8PBB8012	740	8000	1200

Cable trays not included

# BENCH DESKING.

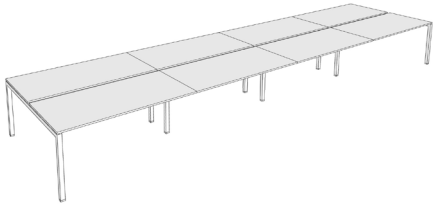

## 8 PERSON BACK TO BACK BENCH 1600D

CODE	H	W	D
8PBB3216	740	3200	1600
8PBB4016	740	4000	1600
8PBB4816	740	4800	1600
8PBB5616	740	5600	1600
8PBB6416	740	6400	1600
8PBB7216	740	7200	1600
8PBB8016	740	8000	1600

Cable trays not included

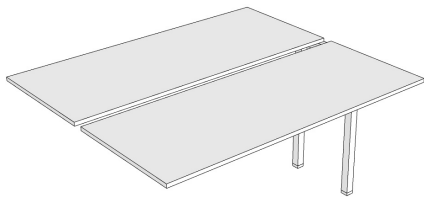

## ADD ON BACK TO BACK BENCH 1200D

CODE	H	W	D
ABB0812	740	800	1200
ABB1012	740	1000	1200
ABB1212	740	1200	1200
ABB1412	740	1400	1200
ABB1612	740	1600	1200
ABB1812	740	1800	1200
ABB2012	740	2000	1200

Cable trays not included

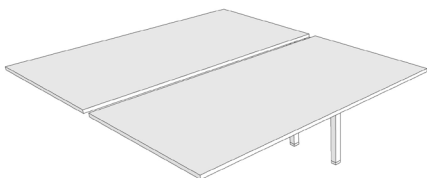

## ADD ON BACK TO BACK BENCH 1600D

CODE	H	W	D
ABB0816	740	800	1600
ABB1016	740	1000	1600
ABB1216	740	1200	1600
ABB1416	740	1400	1600
ABB1616	740	1600	1600
ABB1816	740	1800	1600
ABB2016	740	2000	1600

Cable trays not included

See page 32 for finishes

# BENCH DESKING.

## CABLE TRAYS

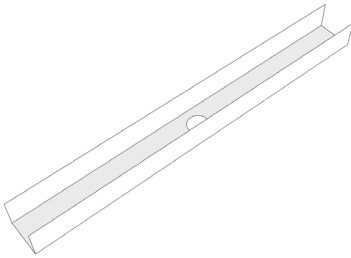

CODE	W
CT08	800
CT10	1000
CT12	1200
CT14	1400
CT16	1600
CT18	1800
CT20	2000

## SCREENS

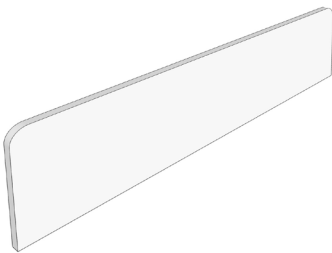

CODE	H	W
SCR08	380	800
SCR10	380	1000
SCR12	380	1200
SCR14	380	1400
SCR16	380	1600
SCR18	380	1800
SCR20	380	2000

Includes bench brackets (frame fixed)

Screens are upholstered in Camira Lucia fabric range as standard

## INFILL BARS

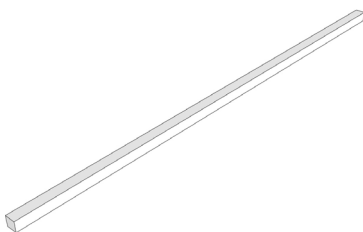

CODE	W
IFB08	800
IFB10	1000
IFB12	1200
IFB14	1400
IFB16	1600
IFB18	1800
IFB20	2000

30mm bars for use on back to back benches where screens are not required

# BENCH DESKING.

## BENCH ACCESSORIES



### POWERDOT

CODE	DESCRIPTION
PD01	Powerdot - USB A&C Charger with 1m lead. Black as standard.



### UNDERDESK POWER BLOCK

CODE	DESCRIPTION
UDPB4	Underdesk 4 socket power block with 3m starter lead



### SINGLE MONITOR ARM

CODE	DESCRIPTION
SMA01	Black as standard



### DOUBLE MONITOR ARM

CODE	DESCRIPTION
DMA02	Black as standard



### CABLE SOCK

CODE	DESCRIPTION
CSK01	Black as standard



# BENCH DESKING.



## SMALL METAL DRAWER

CODE	DESCRIPTION
------	-------------

SMD01 Lockable metal drawer with USB charger. Black finish.



## LARGE METAL DRAWER

CODE	DESCRIPTION
------	-------------

LMD02 Lockable metal drawer with stationery compartments. Black finish.





# BENCH DESKING.



# BENCH DESKING.







# STORAGE.

## CUBE DIVIDER STORAGE, CUPBOARDS & TAMBOURS

Our Storage offers four options within the same carcass design at 800mm and 1000mm external widths. We use quality carcasses which are constructed from 18mm MFC.

Our bookcases, cupboards and tambours all allow for adjustable shelving.

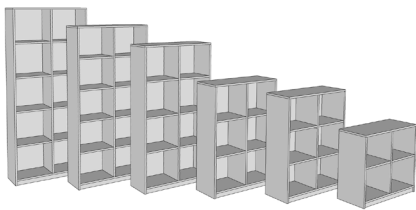

### CUBE DIVIDER STORAGE

CODE	H	W	D
SB874	740	800	350
SB811	1100	800	350
SB812	1200	800	350
SB816	1600	800	350
SB818	1800	800	350
SB820	2000	800	350
SB1074	740	1000	350
SB1011	1100	1000	350
SB1012	1200	1000	350
SB1016	1600	1000	350
SB1018	1800	1000	350
SB1020	2000	1000	350

Self-coloured shelves are included

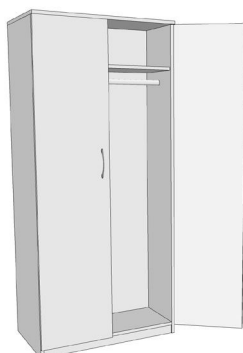

### COAT CUPBOARDS

CODE	H	W	D
CC818	1800	800	600
CC820	2000	800	600
CC1018	1800	1000	600
CC1020	2000	1000	600

Includes hanging rail with shelf above

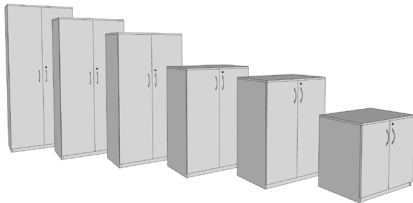

## CUPBOARDS

CODE	H	W	D
SC874	740	800	500
SC811	1100	800	500
SC812	1200	800	500
SC816	1600	800	500
SC818	1800	800	500
SC820	2000	800	500
SC1074	740	1000	500
SC1011	1100	1000	500
SC1012	1200	1000	500
SC1016	1600	1000	500
SC1018	1800	1000	500
SC1020	2000	1000	500

All shelves in 25mm graphite MFC, ordered separately

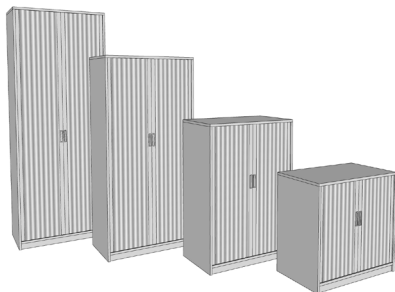

## TAMBOURS

CODE	H	W	D
ST874	740	800	500
ST811	1100	800	500
ST816	1600	800	500
ST820	2000	800	500
ST1074	740	1000	500
ST1011	1100	1000	500
ST1016	1600	1000	500
ST1020	2000	1000	500

All shelves in 25mm graphite MFC, ordered separately  
Silver tambours come as standard, other finishes available on request

## STORAGE INTERNAL FITTINGS

All internal fittings for storage cupboards need to be ordered separately. Shelves are 25mm graphite MFC. Pull out filing frames are available upon request.

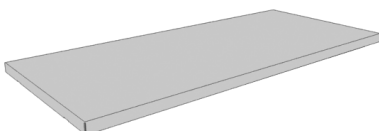

### SHELF - 25mm Graphite MFC

SIZE	CODE
800W UNITS	SH08
1000W UNITS	SH10



# STORAGE.

## CREDENZA

Credenza storage units are constructed from 18mm MFC. 25mm MFC shelves are included that are height adjustable. The 3 door unit has a large double door compartment and a separate single door compartment. The 4 door unit and sliding door units have two compartments. Each compartment is individually locked and all storage units include height adjustable feet.

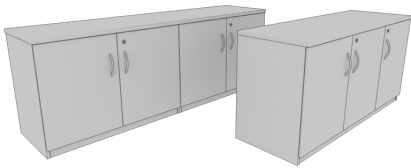

### CREDENZA

CODE	H	W	D
3DCZ1574	740	1500	500
4DCZ2074	740	2000	500

Includes 2x adjustable shelves

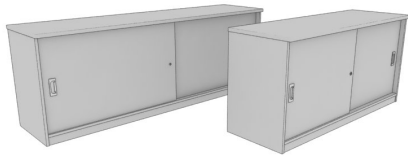

### SLIDING DOOR CREDENZA

CODE	H	W	D
SLCZ1574	740	1500	500
SLCZ2074	740	2000	500

Includes 2x adjustable shelves

As standard, these units come with chrome inset handles



Illustration shows bespoke handle

## PLANTERS

Planter units are constructed from 18mm MFC, these can be fixed on top of most of our cupboard and credenza units to allow for artificial plants without liners.

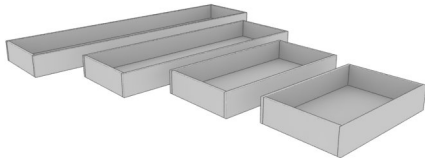

### PLANTERS

CODE	H	W	D
SP0835	150	800	350
SP1035	150	1000	350
SP0850	150	800	500
SP1050	150	1000	500
SP1550	150	1500	500
SP2050	150	2000	500

ARTI SOIL

x1 SACK

Lightweight artificial soil stones available by the sack (one required per planter)



# STORAGE.



## PEDESTALS

The pedestal is an essential part of personal storage in any office design. Our pedestal range comes in a wide variety of heights and drawer configurations that can be combined with our Bench Desking range. All constructed in 18mm MFC, with lockable drawers (via a locking bar system). Our low units are available with seatpads for flexibility. These units have no handles as standard, with extended drawer fronts for 'pull to open'.



### DESK HIGH 3 DRAWER

CODE	H	W	D
PDH3D446	740	425	600
PDH3D448	740	425	800



### UNDER DESK 3 DRAWER

CODE	H	W	D
PUD3D	640	425	600

These pedestals are not suitable for 600mm deep tops.



### SLIM UNDER DESK 3 DRAWER

CODE	H	W	D
SP3D	640	300	600

These pedestals are not suitable for 600mm deep tops.





## LOW MOBILE 2 DRAWER

CODE	H	W	D
PLM2D	550	425	600

Suitable for use with seat pad



## LOW MOBILE 3 DRAWER

CODE	H	W	D
PLM3D	550	425	600

Suitable for use with seat pad



## PEDESTAL SEAT PAD

CODE	W	D
PEDSEAT	425	600

Upholstered in Camira Era as standard





## LOCKERS

Our lockers are suitable for many applications, including:

- Personal Storage.
- Hot Desking / Agile Working.
- Parcel Delivery.
- Locker Rooms.
- Schools / Classrooms.

and many more...

Unlike other manufacturers, we have no standard sizes and can make any size of door/module required. These can be made from a variety of materials including laminates, veneers, Solid Grade Laminate (SGL) and steel. We also offer a large number of lock options to ensure the client receives the best possible solution with the right look, price and, of course, ease of use for application.



## STANDARD SIZES

**Height** 1900mm **Width** 400mm **Depth** 500mm - Lock detail to right handed doors as standard.

Although the above sizes are standard, we can make any width, depth and height to your requirements.

It's that easy!

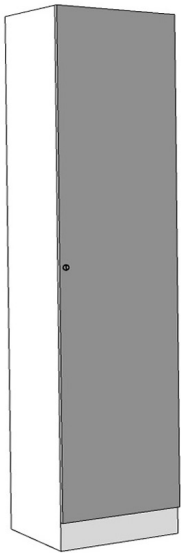

**1 DOOR**

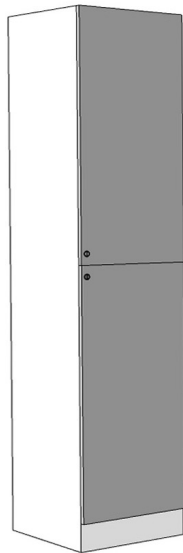

**2 DOOR**

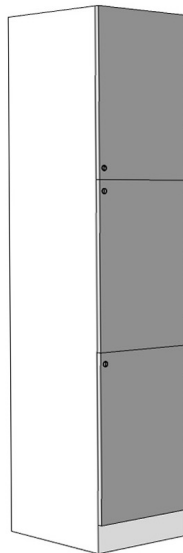

**3 DOOR**

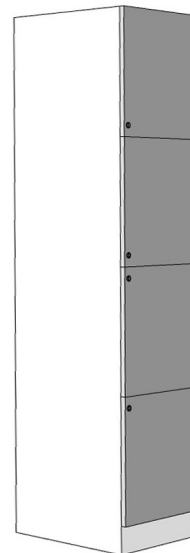

**4 DOOR**

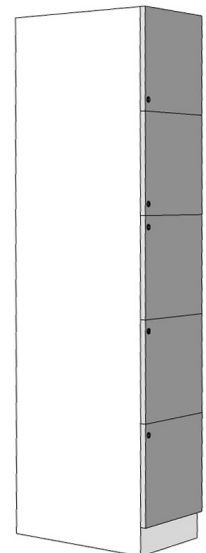

**5 DOOR**

Key locks included as standard. See below for other options

## DESK END LOCKERS

4 door locker unit with 18mm top.

**Height** 1100mm

**Width** 800mm

**Depth** 500mm

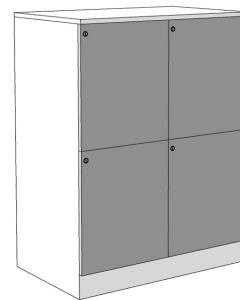

## LOCKS

We offer a wide variety of locks, ranging from a simple key lock to fully networked intelligent systems.

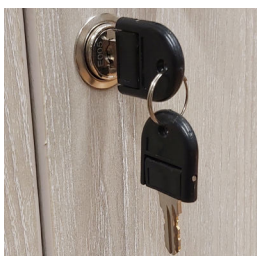

**Standard Key  
Included**



**Key with handle**



**Manual  
Combination**



**Digital  
Combination**

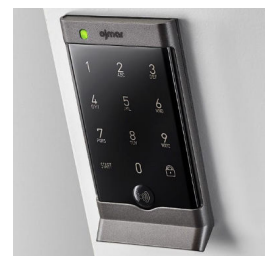

**Smart/Bluetooth  
/Digital**

Prices are per lock. Specialist systems available upon request



# TABLES.

Our wide range of tables are suitable for a variety of applications, offering choice and flexibility on finishes. Sizes of tables can be tailored to your needs and all our table legs can be powder coated in special finishes.

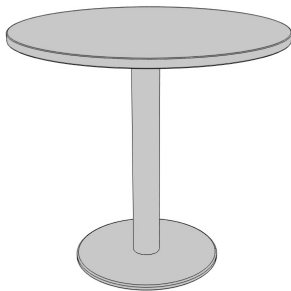

## CIRCULAR TABLES

CODE	H	DIAMETER
COFFEET60	400	600
TCMT80	740	800
TCMT90	740	900
TCMT10	740	1000
TCMT12	740	1200
TCMT14	740	1400
TCMT15	740	1500
TCMT16	740	1600

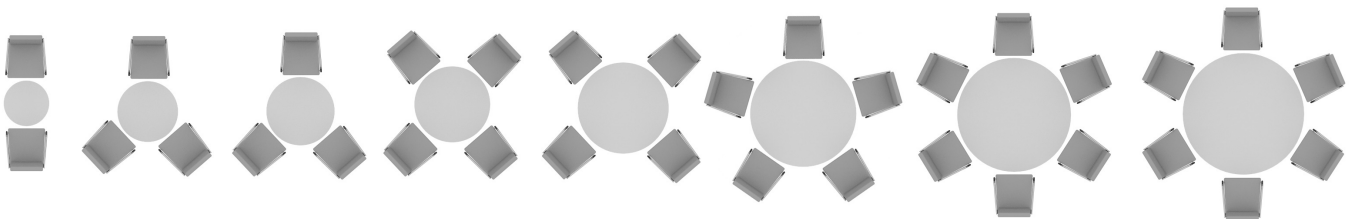

600 dia  
Seats: 2-3

800 dia  
Seats: 3

900 dia  
Seats: 3-4

1000 dia  
Seats: 4

1200 dia  
Seats: 4-5

1400 dia  
Seats: 5-6

1500 dia  
Seats: 6

1600 dia  
Seats: 6-7

Our stylish rectangular table ranges use the same system as our bench desking but with an 'A' frame, or choose from our minimalist style benches. These are all suitable for meeting rooms or breakout spaces. We can also offer cable management solutions for specific requirements.

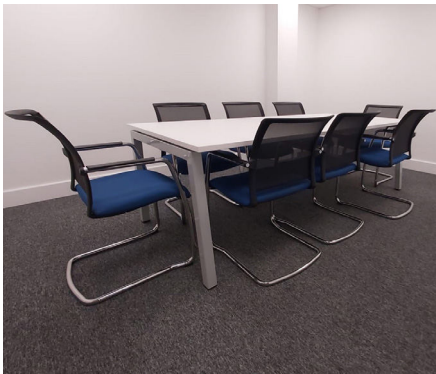

## RECTANGULAR TABLES 'A' FRAME

CODE	LEAVES	H	W	D
TRM1608	1 piece top	740	1600	800
TRM1809	1 piece top	740	1800	900
TRM2010	1 piece top	740	2000	1000
TRM2512	1 piece top	740	2500	1200
TRM3012	2 piece top	740	3000	1200
TRM3512	2 piece top	740	3500	1200
TRM4012	2 piece top	740	4000	1200
TRM4512	3 piece top	740	4500	1200
TRM5012	3 piece top	740	5000	1200
TRM3515	2 piece top	740	3500	1500
TRM4015	2 piece top	740	4000	1500
TRM4515	3 piece top	740	4500	1500
TRM5015	3 piece top	740	5000	1500

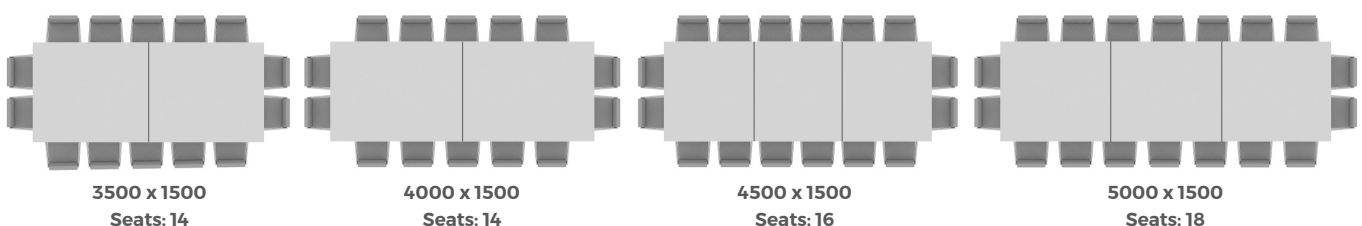
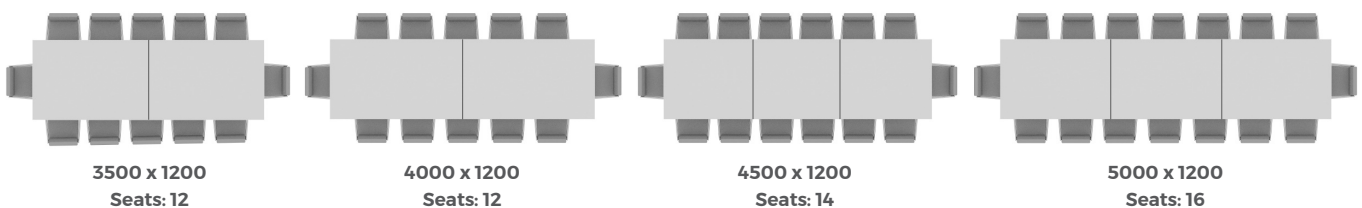
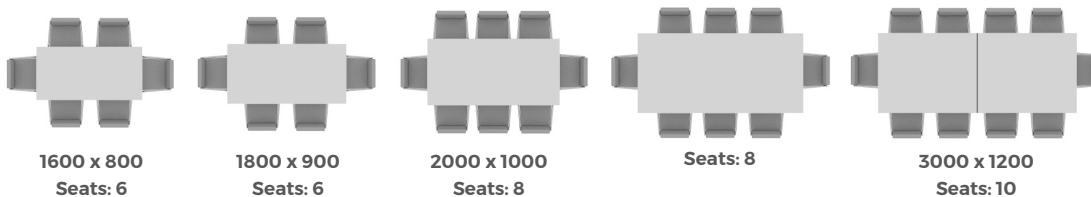

# TABLES.

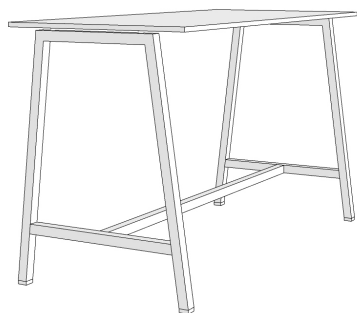

## POSEUR BAR 'A' FRAME

CODE	H	W	D
TPB1608	1050	1600	800
TPB1809	1050	1800	900
TPB2010	1050	2000	1000
TPB2512	1050	2500	1200
TPB3012	1050	3000	1200
TPB3512	1050	3500	1200
TPB4012	1050	4000	1200
TPB4512	1050	4500	1200
TPB5012	1050	5000	1200
TPB4015	1050	4000	1500
TPB4515	1050	4500	1500
TPB5015	1050	5000	1500





## TABLES.





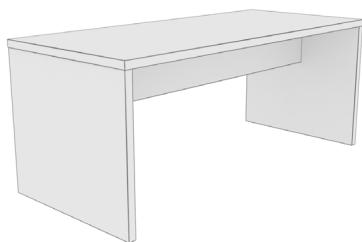

### PANEL BENCH TABLE

CODE	H	W	D
PBT14	740	1400	800
PBT16	740	1600	800
PBT18	740	1800	800
PBT20	740	2000	800

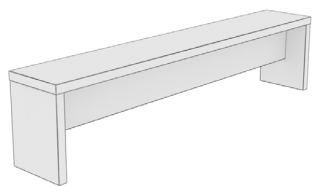

### PANEL BENCH SEATING

CODE	H	W	D
PBS14		BENCH FOR 1400W TABLE	
PBS16		BENCH FOR 1600W TABLE	
PBS18		BENCH FOR 1800W TABLE	
PBS20		BENCH FOR 2000W TABLE	

This is for one bench seat only

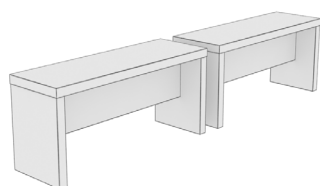

### SPLIT PANEL BENCH SEATING

CODE	H	W	D
SPBS14		BENCH FOR 1400W TABLE	
SPBS16		BENCH FOR 1600W TABLE	
SPBS18		BENCH FOR 1800W TABLE	
SPBS20		BENCH FOR 2000W TABLE	

This is for a set of two

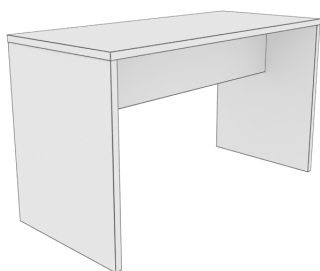

## PANEL POSEUR BAR

CODE	H	W	D
PPB14	1050	1400	800
PPB16	1050	1600	800
PPB18	1050	1800	800
PPB20	1050	2000	800

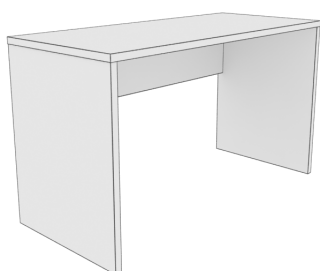

## SINGLE SIDED PANEL POSEUR BAR

CODE	H	W	D
SPPB14	1050	1400	600
SPPB16	1050	1600	600
SPPB18	1050	1800	600
SPPB20	1050	2000	600

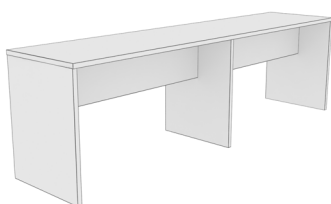

## DOUBLE SIDED PANEL POSEUR BAR

CODE	H	W	D
DPPB25	1050	2500	800
DPPB30	1050	3000	800

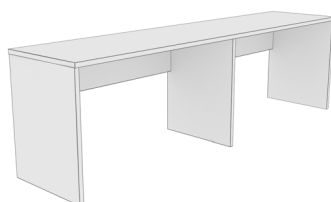

## DOUBLE SINGLE SIDED POSEUR BAR

CODE	H	W	D
DSPPB25	1050	2500	600
DSPPB30	1050	3000	600



# TABLES.

## TABLE ACCESSORIES



### POWERDOT

CODE	DESCRIPTION
PD01	Powerdot - USB A&C Charger with 1m lead. Black as standard.



### ROTATION POWER BLOCK

CODE	DESCRIPTION
TPB01	Recessed Power Block/ USB Charger/ RJ45 Coupler, and HDMI coupler with 3m starter lead. Black as standard.



### TABLETOP POWER BLOCK

CODE	DESCRIPTION
PRB01	Power/ USB Charger, with 3m starter lead. Black as standard.



### CABLE SOCK

CODE	DESCRIPTION
CSK01	Black as standard



# SEATING.

Comfortable, versatile and functional seating available in a wide selection of Fabrics and Faux Leathers to suit any work environment and budget. Camira Citadel or Phoenix fabrics as standard. Others fabrics are available upon request.



## DANBURY TASK CHAIR

CODE

SDTC

### DIMENSIONS

Total Height: 1060mm Total Width: 670mm Total Depth: 670mm  
 Seat Height: 470-600mm Seat Width: 510mm Seat Depth: 470mm  
 Back Height: 550mm

### FEATURES

High back task mesh chair. Anti shock synchronous mechanism. Seat height adjustment. Side operated bodyweight tension control. Large seat. Adjustable lumbar support. Height adjustable arms. Black 5 Star base.

### OPTIONAL EXTRAS UPON REQUEST

Headrest. Fold down arms. Height and twist adjustable arms. Height adjustable fore/aft sliding arms. Seat slide mechanism. Polished domed base. Memory foam on seat. Coccyx cut out.



# SEATING.



## COLNE OPERATOR CHAIR

CODE

SCOC

### DIMENSIONS

Total Height: 1070mm Total Width: 660mm Total Depth: 670mm  
Seat Height: 480-620mm Seat Width: 510mm Seat Depth: 480-530mm  
Back Height: 600-670mm

### FEATURES

Fully upholstered high back chair with an ergonomic curved back to offer additional support and encourage good posture, making this an exceptionally comfortable chair. Features include a heavy duty synchronous mechanism. Bodyweight tension control. Seat height adjustment. Ratchet back height adjustment. Suitable for users up to 150kg. Fold-down height adjustable arms. Seat slide. Independent seat/back adjustment. Inflatable lumbar support. Generous seat and back.

### OPTIONAL EXTRAS UPON REQUEST

4D adjustment arm. Height adjustable fore/aft sliding arms. Height and twist adjustable arms. Height and width adjustable arms (adds 60mm each side to the width). Triple air bag lumbar support. Polished aluminium base. Coccyx cut out. Memory foam. 24-hour version available (height and twist arms will be used). Inflatable seat support



## WALTON MEETING CHAIR

CODE

SWMC

### DIMENSIONS

Total Height: 800mm Total Width: 535mm Total Depth: 550mm  
Seat Height: 450mm Seat Width: 450mm Seat Depth: 435mm  
Back Height: 385mm Arm Height: 670mm

### FEATURES

Stylish chrome cantilever visitor chair with PU arm cover and mesh back in black. Stackable 4 high.

### OPTIONAL EXTRAS UPON REQUEST

Polypropylene arms. Anti-panic writing tablet (stacks 3 high). Trolley



## DRAUGHTSMAN CHAIR

CODE

SDMC

### DIMENSIONS

Total Height: 1130mm Total Width: 500mm Total Depth: 600mm

Seat Height: 560-830mm Seat Width: 490mm Seat Depth: 460mm

Back Height: 540mm

### FEATURES

Square mesh back draughtsman chair with 2-lever back rake mechanism.

Seat height adjustment. No arms. Wheel operated back height adjustment.

Fitted with glides. Chrome plated adjustable foot ring.

All upholstered seating prices are for Group 1 fabrics (Camira Phoenix or Era ranges etc.)



## PORTLAND STOOL

CODE

SPLS

### DIMENSIONS

Total Height: 1130mm Total Width: 520mm

Seat Height: 760mm Seat Width: 440mm Seat Depth: 490mm

### FEATURES

Polypropylene wipe clean high stool with chrome frame.

Available in Black, Grey, Red, Navy, Lime, White, Mustard, Turquoise and Plum.

Stacks 4 high.





# FINISHES.

Below are our standard finishes which are readily available. As with all Nott office products, special finishes and materials are available upon request.

## DESKTOPS

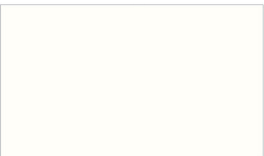

**ALPINE WHITE**

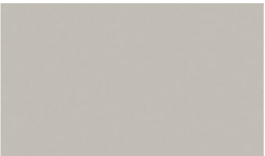

**PEARL GREY**



**PEBBLE GREY**



**STONE GREY**



**DUST GREY**



**LAVA GREY**

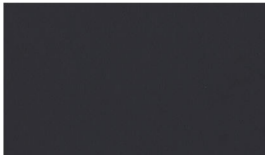

**CARBON GREY**



**LIGHT CHICAGO CONCRETE**



**ANTHRACITE LINEN**

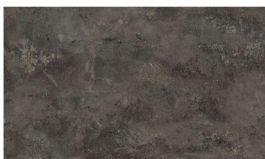

**ANTHRACITE METAL ROCK**

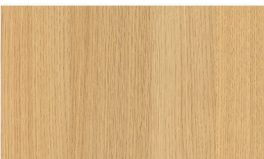

**LIGHT SORANO OAK**



**BEIGE LORENZO OAK**



**GREY NEBRASKA OAK**

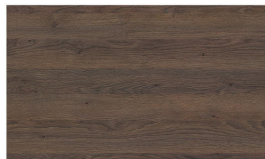

**TOBACCO GLADSTONE OAK**

Desktops and storage are 18mm panels. Panel bench products are 36mm



## METALWORK

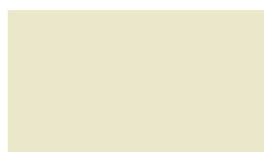

**RAL 1013**  
OYSTER WHITE



**RAL 1019**  
GREY BEIGE



**RAL 3012**  
BEIGE RED



**RAL 7012**  
BASALT GREY



**RAL 7016**  
ANTHRACITE GREY



**RAL 7031**  
BLUE GREY



**RAL 7032**  
PEBBLE GREY



**RAL 7033**  
CEMENT GREY



**RAL 7034**  
YELLOW GREY



**RAL 7038**  
AGATE GREY



**RAL 7045**  
TELEGREY 1





# OUR OTHER SERVICES.



## SPECIALS/ PANEL FABRICATION

We have the capabilities to produce Metal products in a wide range of shapes and sizes. We can produce to customer supplied drawings or produce working drawings in house, based on customer specifications and requirements.



## SITE VISITS & CONSULTATIONS

We offer a unique furniture matching service and are willing to engage with your customer to ensure all details are recorded to manage client expectation.



## 3D RENDERING & VISUALISATION

Our design department uses the most advanced tools on the market to produce photo real product renders and room visualisation, this is becoming an ever more important tool in winning tenders.



## PRODUCT DESIGN

Our design and prototype departments work closely with customers to develop new products and ranges. The process starts with a design brief and progresses through to full working prototype and finally to delivered product.



## DIRECT DELIVERIES

We operate our own fleet of vehicles with experienced drivers, trained in the correct handling of our products.



## FURNITURE ASSEMBLY

We can produce fully assembled furniture to customer supplied designs, alternatively our in house design team can produce drawings and manufacture prototypes if required.

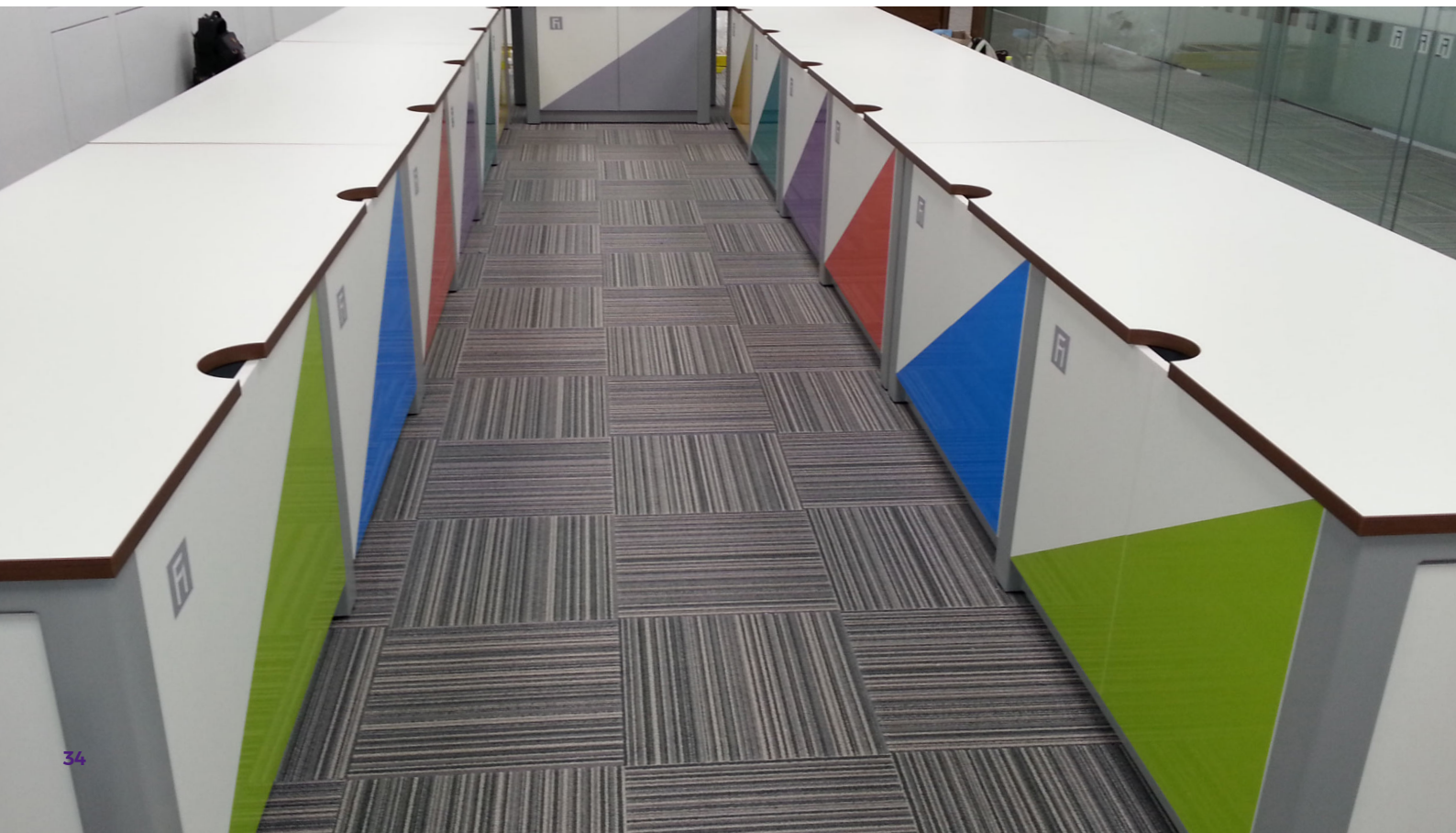

# SERO.



**STORAGEWALL**



**RECEPTIONS**

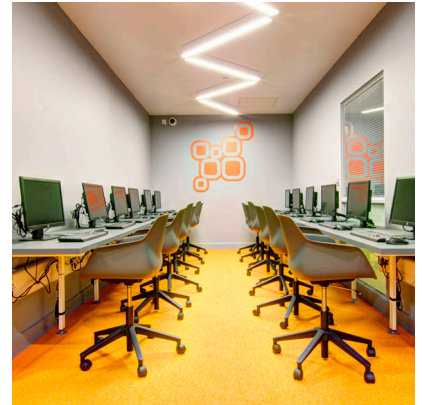

**PERIMETER BENCHING**



**BESPOKE PROJECTS**

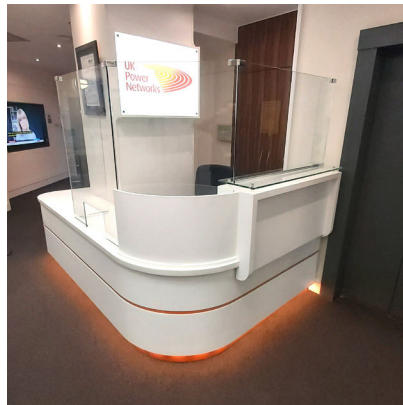

**BIO-OFFICE**



**HUBLOK**



**Manufactured in the UK**

**QUILLS GROUP**  
OFFICE INTERIORS

**HUBLOK**



STORAGEWALL|uk

**bio**ffice

e: [interiors@quillsuk.co.uk](mailto:interiors@quillsuk.co.uk)  
t: 0845 078 0324  
w: [quillsinteriors.co.uk](http://quillsinteriors.co.uk)